

Introduction to Robotics

Assignment #4

Due: 05.06.2018, 23:59

Task 4.1 (9 points) Jacobian and singularities: Figure 1 shows a 2-joint planar manipulator with the following constraints: $10^\circ \leq \theta_1 \leq 350^\circ$, $0^\circ < \theta_2 < 360^\circ$ and $l_1 > l_2$.

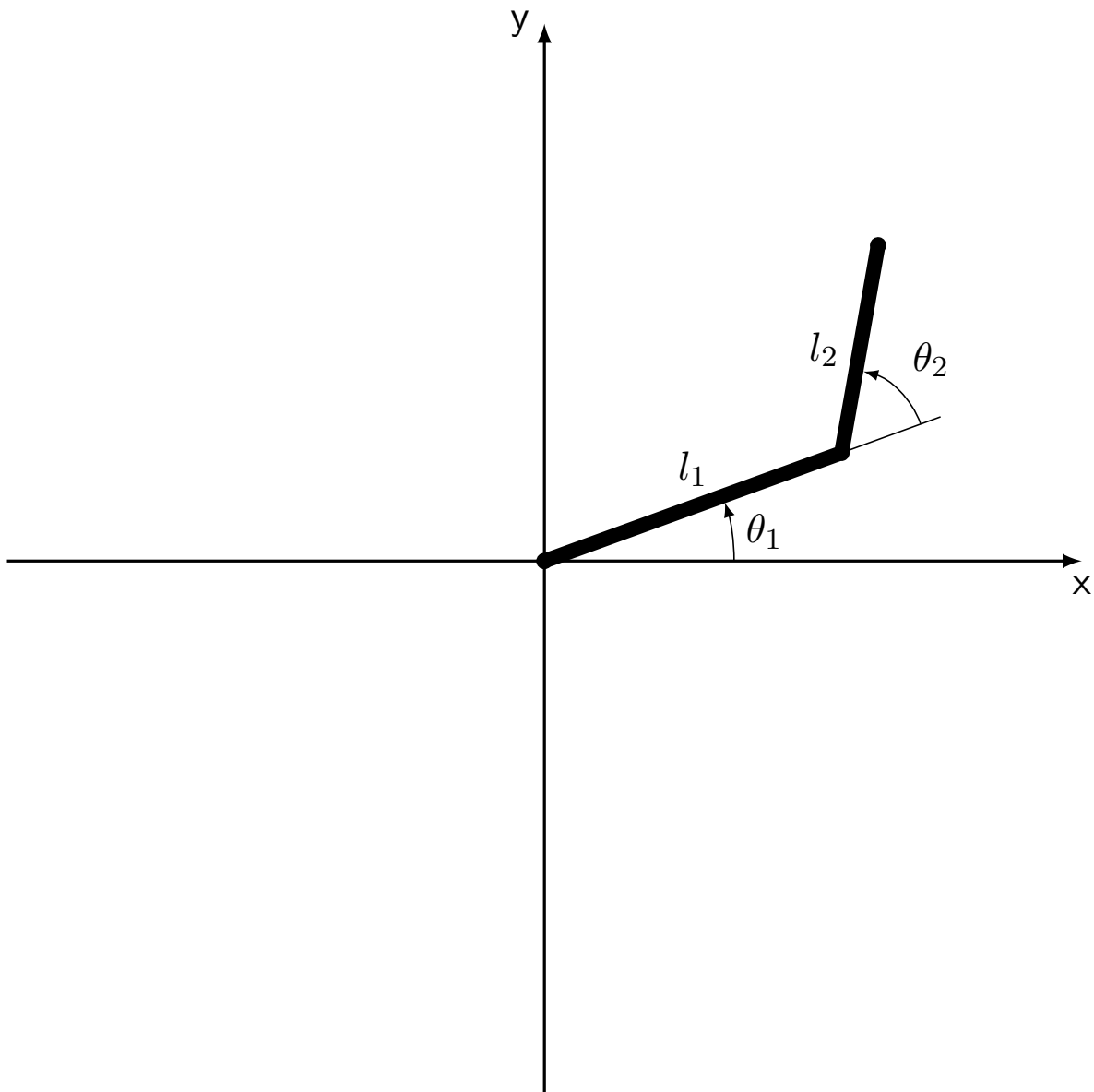

Figure 1: 2-joint planar manipulator.

4.1.1 (2 points): Illustrate the workspace of the manipulator.

4.1.2 (3 points): Determine the Jacobian matrix for the manipulator.

4.1.3 (2 points): Determine the singular configurations of the manipulator (mathematically or geometrical).

4.1.4 (2 points): Outline and explain the determined singular configurations (mathematically or geometrical).

Task 4.2 (2 points) Jacobian: Extend the Jacobian matrix for the 3-joint planar manipulator shown in figure 2.

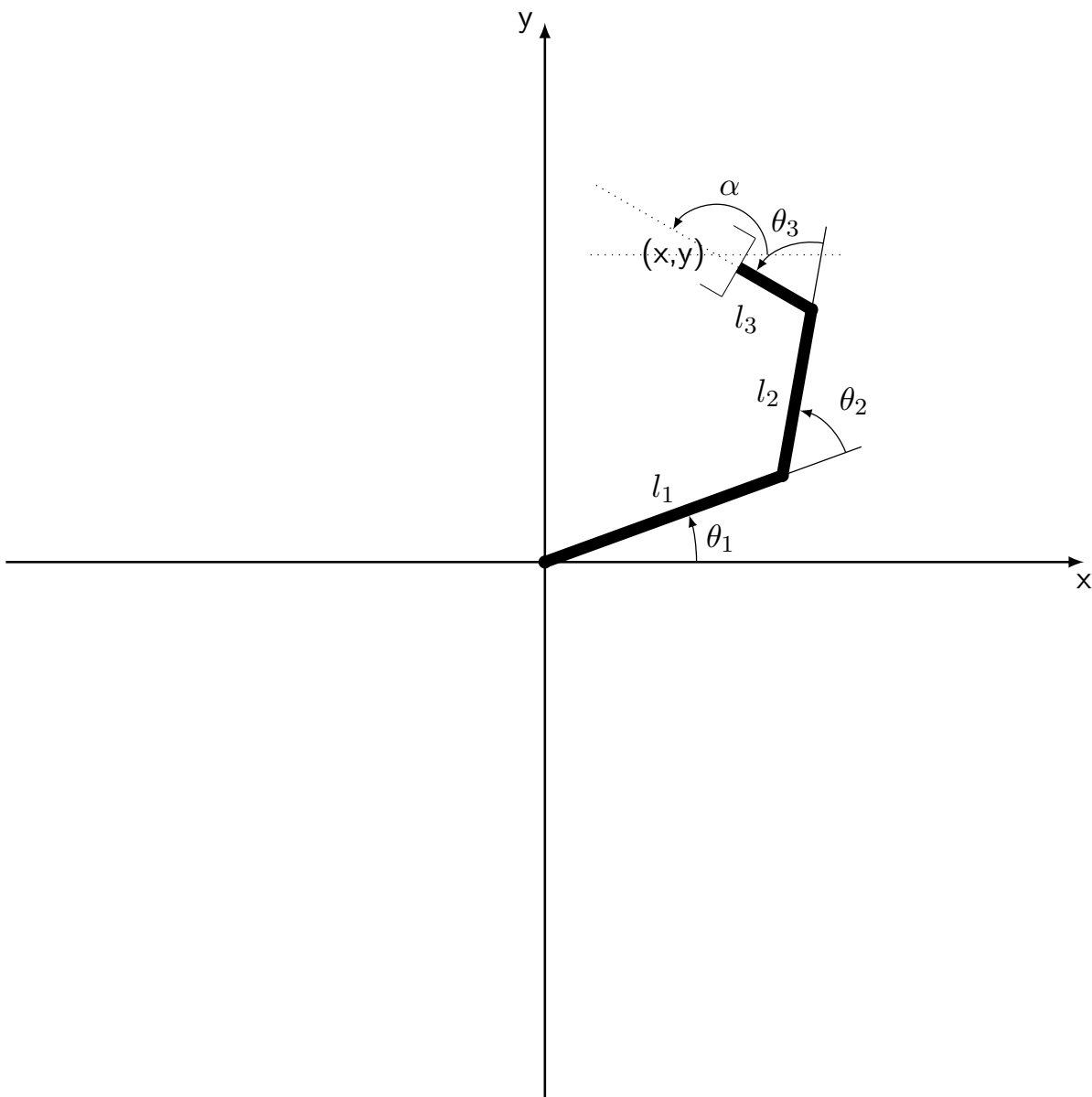

Figure 2: 3-joint planar manipulator.

Task 4.3 (4 points) Singularities of a PUMA560: Consider a PUMA560 manipulator as shown in figure 3. Explain at least three of the possible singular configurations!

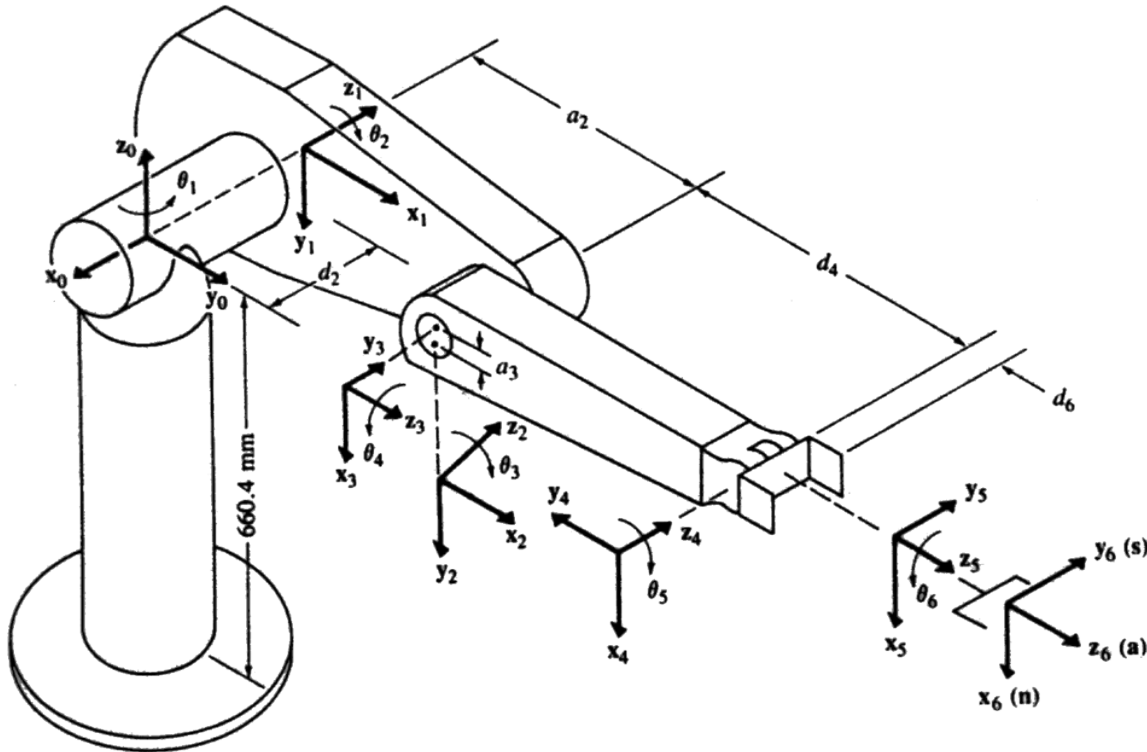

Figure 3: PUMA560 manipulator.

Hint: Workspace boundary singularities occur whenever the manipulator is fully extended or is folding back onto itself.

Workspace-internal singularities occur if two or more joint axes enter a collinear configuration.

Task 4.4 (5 points) Homogenous transformation: Derive the homogenous transformation $Rot_{\vec{k},\theta}$ (slide 165), which describes a rotation of θ around an arbitrary vector \vec{k} ($\vec{k} = k_x\mathbf{i} + k_y\mathbf{j} + k_z\mathbf{k}$).